



AMC Building Material, LLC

Product Specifications 2018

AMC Building Materials, LLC

AMC Building Material was established in 2015, we supplies quality cabinet, flooring, countertop, sinks and faucets for your next renovation project. Our kitchen materials include three different (European, Shaker, Classic) style cabinets, and (Granite, Quarte) countertop.

All of our cabinets and vanities are constructed with 100% solid wood doors and frames, 1/2" to 5/8" thick plywood boxes, soft close metal door hinges, full extension drawer with soft close metal glides, and more. We insist the highest standard, overall quality, functionality, and value of our products.

All AMC cabinets are Ready-To-Assemble (RTA) and Semi-Customize to our customers' specific. As our own manufacturer, we are able to maintain quality control and strict supervision over our cabinets production process through high-tech machinery and detailed hand-crafting. And we value our growth and continued improvement just as our customers do.

Contact us or visit our website to see examples in our Salt Lake City show room. Our renovation staff is ready to answer questions, customize building supplies and high quality imported materials. We work with homeowners, builders and contractors around the Utah state.

European Style Color Options



Black



White



Brown

Shaker Style Color Options



White Shaker



Grey Shaker



Espresso Shaker

Classic Style Color Options



Chocolate



Saddle



Cognac



Moonshine



Antique White

AMC Building Materials, LLC

Cabinets Specifications

BASE CABINETS

Base Cabinet: 1 Drawer, 1 Door

Base Cabinet: 1 Drawer, 2 Doors



B09

B12

B15

B18

B21

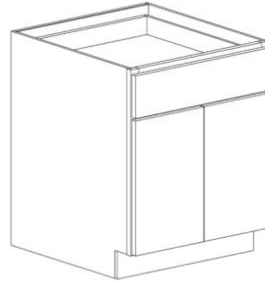

B24

B27

Base Cabinet: 2 Drawers, 2 Doors

Sink Base Cabinet: 1 Drawer Face, 2 Doors

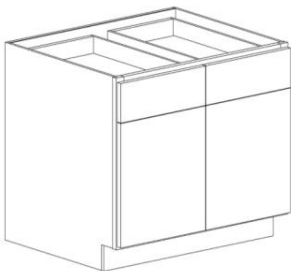

B30

B33

B36

B42

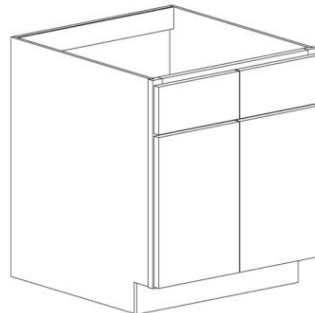

SB30

SB33

SB36

SB42

Drawer Base Cabinet: 3 Drawers

Blind Corner Cabinet: 1 Drawer, 1 Door

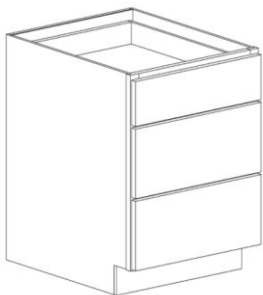

DB12

DB27

DB15

DB30

DB18

DB21

DB24

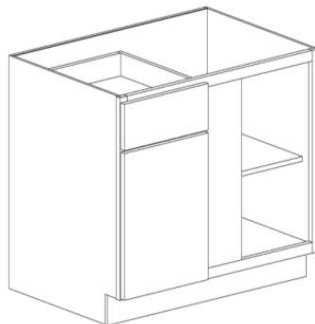



BBC36L

BBC36R

BBC42L

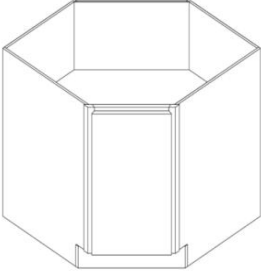
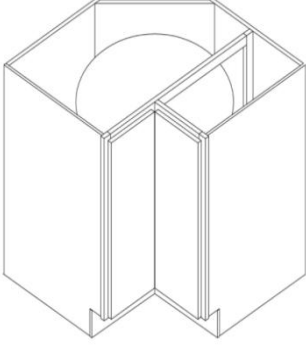
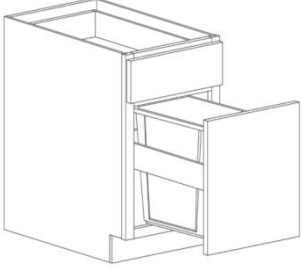
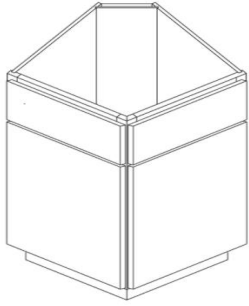
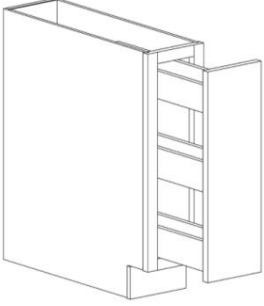
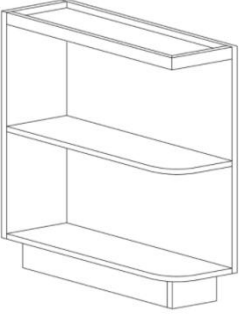
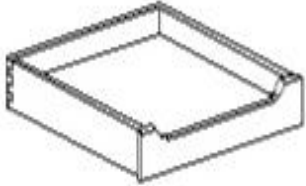
BBC42R

Base Diagonal Corner: 1 Door			Base Lazy Susan: 2 Doors, 2 Turning Table		
	BDC36			BLS33	
				BLS36	
Base Waste Basket: 1 Drawer, 1 Pull Out Door			Base End Cabinet: 2 Dummy Drawers, 2 Doors		
	BWBK18			BEC24	
Base Spice Rack: 1 Door with 1 Pull Out Rack			Base End Shelf (L/R): Open Shelf		
	BSPR09			BES12L	
				BES12R	
Roll Out Drawer Kit: Match Base Cabinet			Front Drawer: Separate Drawer		
	ROT18	ROT30		FD30	
	ROT21	ROT33			
	ROT24	ROT36			
	ROT27				

WALL CABINTES

Wall Cabinet: 1 Door, with 30"H, 36"H, 42"H

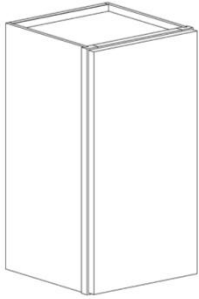

W0930	W1830
W0936	W1836
W0942	W1842
W1230	W2130
W1236	W2136
W1242	W2142
W1530	
W1536	
W1542	

Wall Cabinet: 2 Doors, with 30"H, 36"H, 42"H

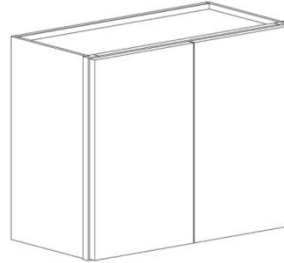

W2430	W3330
W2436	W3336
W2442	W3342
W2730	W3630
W2736	W3636
W2742	W3642
W3030	W4230
W3036	W4236
W3042	W4242

Wall Bridge Cabinet: 2 Doors, 30"W, 12"D

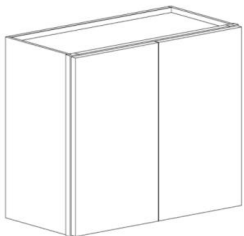

W3012	
W3015	
W3018	
W3021	
W3024	

Wall Bridge Cabinet: 2 Doors, 36"W, 12"D or 24"D

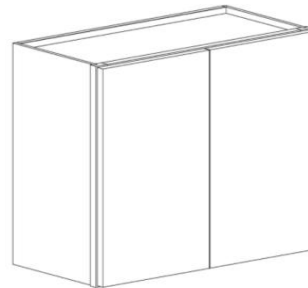

W3612	W361824
W361224	W3621
W3615	W362124
W361524	W3624
W3618	W362424

Wall Diagonal Cabinet: 1 Door

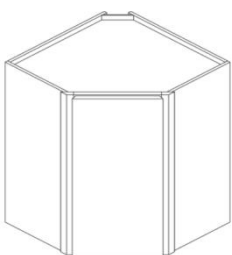

WDC2430	
WDC2436	
WDC2442	

Wall Corner End: 2 Doors

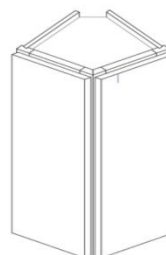



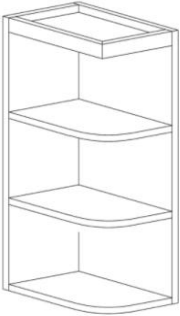
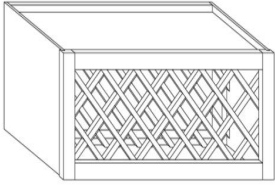
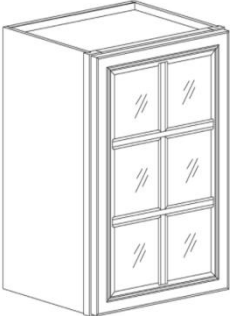
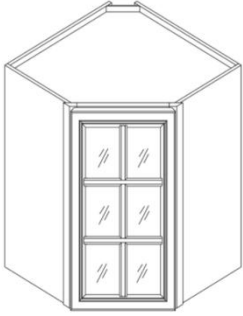

WEC1230	
WEC1236	
WEC1242	

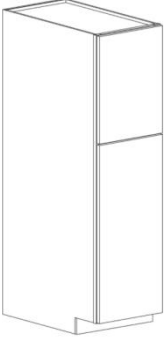
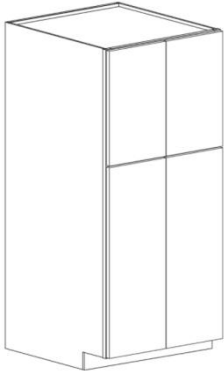
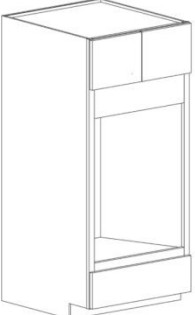
Wall end Shelf: 12" W, L/R			Wine Rack Cabinet: 30"W or 36"W		
	WES1230L			WRC3015	
	WES1230R			WRC3018	
	WES1236L			WRC3615	
	WES1236R			WRC3618	
	WES1242L				
	WES1242R				
Wall Cabinet Glass Door			Wall Diagonal Corner		
	WMD1212	WMD2115		WDCMD2430	
	WMD1215	WMD2412		WDCMD2436	
	WMD1512	WMD2415		WDCMD2442	
	WMD1515	WMD2430			
	WMD1530	WMD2436			
	WMD1536	WMD2442			
	WMD1542	WMD3012			
	WMD1812	WMD3015			
	WMD1815	WMD3030			
	WMD1830	WMD3036			
	WMD1836	WMD3042			
	WMD1842	WMD3312			
WMD2112	WMD3315				



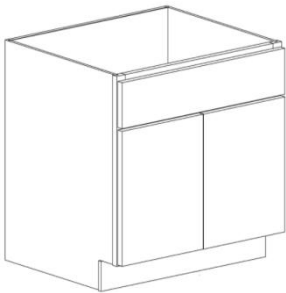

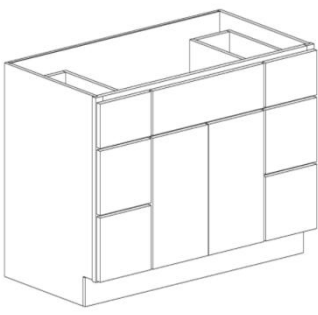
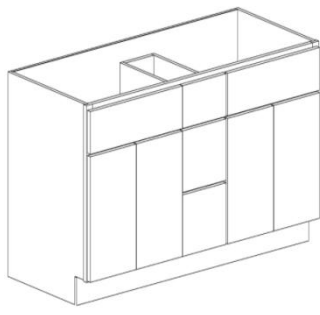
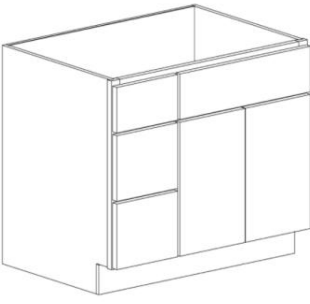

TALL CABINETS





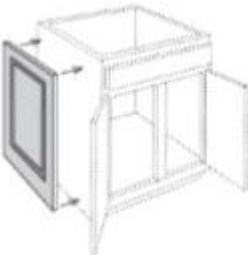
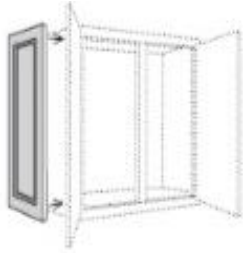
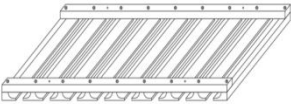

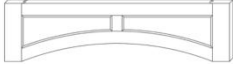
Pantry: 2 Doors			Pantry: 4 Doors		
	PC1884			PC2484	PC3096
	PC1890			PC2490	
	PC1896			PC2496	
				PC3084	
				PC3090	
Oven Cabinet: 33"W					
	OC3384				
	OC3390				
	OC3396				



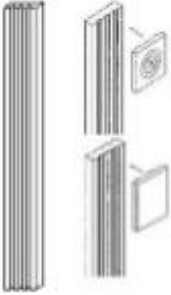

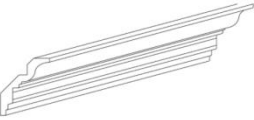
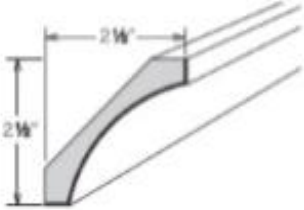
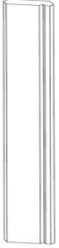
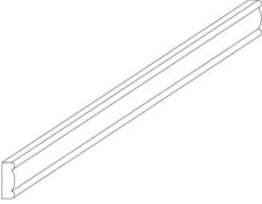
VANITIES

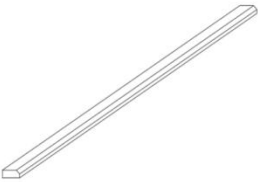
Sink Base Vanity: 1 Drawer Face, 2 Doors			Vanity Drawer Base: 3 Doors		
	VSB24			VD12	
	VSB27			VD15	
	VSB30			VD18	
	VSB33			VD21	
	VSB36			VD24	
Double Drawers Vanity: 1 Sink with 2 Side Drawers			Double Sinks Vanity: 2 Sinks with Central Drawer		
	VDD48			VCD60	
Vanity Sink with Side Drawers: 1 Sink with 3 Drawers			Line Cabinet: 1 Door, 2 Drawers, 45" H		
	VSD30L			LC12	
	VSD30R				
	VSD36L				
	VSD36R				
	VSD42L				
	VSD42R				

ACCESSORIES

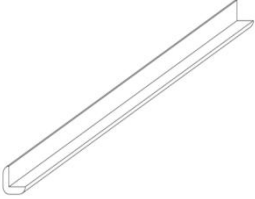
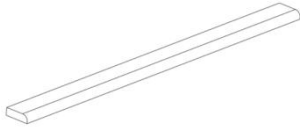
Corbel: Traditional Design			Corbel: Classic Design		
	AC-L			CBL-L	
	AC-M			CBL-M	
	AC-S			CBL-S	
Base False Door: 24"W			Wall False Door: 12" W (30"H, 36"H, 42"H)		
	BDD24			WDD1230	
				WDD1236	
				WDD1242	
Stem Glass Holder: 30"W or 36"W			Valance: 36"L or 48"L		
	SGH30			VAL36	
	SGH36			VAL48	
					
				RPV36	
				RPV48	
Post(Spool Design): 34 1/2"H			Filler: 3" W or 6" W		
	SPOOL			WF0342	
				WF0396	
				WF0642	
				WF0696	

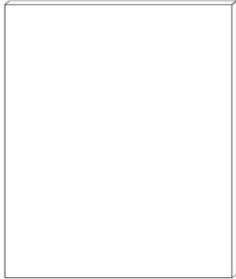
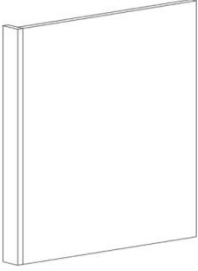
Fluted Filler:with Square or Flower Design		Toe Kick: 96"L		
	RWF0342	FCB		TK8
	RWF0396	FNB		
	RWF0642			
	RWF0696			
Classic Crown Molding: 3 1/2"H, 96"L		Cove Crown Molding: 2 1/2"H, 96"L		
	CCM8		AST	
Angle Crown Molding: 96"L		Light Rail Molding: 96"L		
	AMC8		IVI8	
Triple Bead Edge Molding: 96"L		Ogee Molding: 96"L		
	TBM8		OGM8	
Countertop Edge Molding: 96"L		Inside Corner Molding: 96"L		
	CTM8		ICM8	

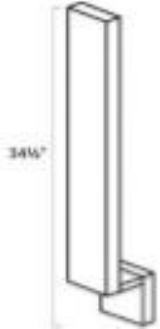
Outside Corner Molding: 96"L		Scribe Molding: 96"L	
	OCM8		SM8
Refrigerator Panel: with 3"W Front Filler		Side Panel: Plywood Panel 5/8"T, 48"W, 96"H	
	RRP		PNL4896
Dishwasher Panel: with 3"W Front Return		Base Sink Panel: 96"L	
	DWR		BP3696
			BP4896
Base Filler: 34 1/2"H, 3"W, 3/4"D			
	BF3		